

coemmar



Fiera **1200**

**manuale
di istruzioni
instructions
manual**

**1ª edizione, ottobre 2003
1st edition, october 2003**

Fiera 1200

numero di serie/serial number

data di acquisto/date of purchase

fornitore/retailer

indirizzo/address

cap/città/suburb

provincia/capital city

stato/state

tel./fax/

*Prendete nota, nello spazio apposito, dei dati relativi al modello e al rivenditore del vostro **Fiera 1200**: in caso di richiesta di informazioni, pezzi di ricambio, servizi di riparazione o altro ci permetteranno di assistervi con la massima rapidità e precisione.*

*Please note in the space provided above the relative service information of the model and the retailer from whom you purchased your **Fiera 1200**: This information will assist us in providing spare parts, repairs or in answering any technical enquiries with the utmost speed and accuracy.*

ATTENZIONE: la sicurezza dell'apparecchio è garantita solo con l'uso appropriato delle presenti istruzioni, pertanto è necessario conservarle.

WARNING: the security of the fixture is granted only if these instructions are strictly followed; therefore it is absolutely necessary to keep this manual.

Index

1. Packaging	Pag. 26
2. Transportation	„ 26
3. Important safety information	„ 26
4. Lamp: installation and replacement	„ 27
5. Operating voltage and frequency	„ 29
6. Mechanical installation	„ 29
7. Mains connection	„ 30
8. Signal connection	„ 31
9. Powering up	„ 32
10. DMX addressing	„ 32
11. Display panel functions	„ 33
11.1 Function setting (FUnc)	„ 33
11.2 Measure and test (MEAS)	„ 34
11.3 Quick guide to menu navigation	„ 35
11.4 Rapid scrolling	„ 35
12. DMX 512 operation	„ 37
13. Aligning the lamp in the optical path and adjusting the beam	„ 37
14. Turning on the Fiera 1200 without articulated movement	„ 37
15. Resetting the counter	„ 38
16. Automatic repositioning functions	„ 38
17. Altering the operating voltage and frequency (Reserved for technical staff)	„ 39
17.1 Selecting an operating voltage and frequency of the lamp different to the factory preset	„ 39
17.2 Selecting the transformer operating voltage	„ 40
18. Mechanical adjustments	„ 41
18.1 Altering the beamspread using optional filters	„ 41
18.2 Adjusting barndoors	„ 43
19. Automatic internal functions	„ 44
20. Maintenance	„ 44
21. Electronic motor alignment	„ 45
22. Error messages	„ 45
23. Spare parts	„ 45

English

Congratulations on having purchased a **coemar** product. You are assured of a projector of the highest quality, both in the componentry used and in the technology. We reiterate our invitation for you to complete the information on the previous page to expedite any request for service information or spares (in case of problems encountered either during, or subsequent to, installation). This information will assist in providing prompt and accurate advice from your **coemar** service centre.

1. Packaging

Following the instructions and procedures outlined in this manual will ensure the maximum efficiency of this product for years to come.

Open the packaging and ensure that no part of the equipment has suffered damage in transit. In case of damage to the equipment, contact your carrier immediately by telephone or fax, following this with formal notification in writing.

packing list

Ensure the packaging contains:

1 **Fiera 1200**

- 1 instruction manual
- 2 U-shaped cam-locking suspension device
- 2 additional lenses

2. Transportation

The **Fiera 1200** should be transported in its original packaging or in a **coemar** approved flight case.

During transportation, the packaging should ensure that the articulated movement of the **Fiera 1200** should be blocked.

3. Important safety information

Fire prevention:

1. **Fiera 1200** utilises a Philips 1200 MSD, 1200 MSR or 1200 MSR/2 lamp; the use of any other lamp is not recommended and will null and void the fixture's warranty.
2. Never locate the fixture on any flammable surface.
3. The minimum distance from any flammable materials: 0,5 m.
4. The minimum distance from the closest illuminable surface: 2 m.
5. Replace any blown or damaged fuses only with those of an identical value. Refer to the schematic diagram if there is any doubt.
6. Connect the projector to the mains power via a thermal-magnetic circuit breaker.

Preventing electric shock:

1. High voltage is present in the internals of the unit. Isolate the projector from mains supply prior to performing any function which involves touching the internals of the unit, including lamp replacement.
2. For mains connection, adhere strictly to the guidelines outlined in section 7 of this manual.
3. The level of technology inherent in the **Fiera 1200** necessitates the use of specialist personnel for all service applications; refer all work to your authorised **coemar** service centre.
4. A good earth connection is essential for proper functioning of the projector. Never operate the unit without proper earth connection.
5. Do not locate the fixture in an exposed position, or in areas of extreme humidity. A steady supply of circulating air is essential.

Protection against ultraviolet radiation:

1. Never turn on the lamp if any of the lenses, filters, or the housing is damaged; their respective functions will only operate efficiently if they are in perfect working order. Never look directly into the lamp when it is operating.

Safety:

1. The projector should always be installed with bolts, clamps, and other fixings which are suitably rated to support the weight of the unit.
2. Always use a secondary safety chain of a suitable rating to sustain the weight of the unit in case of the failure of the primary fixing point.
3. The external surfaces of the unit at various points may exceed 150°C. Never handle the unit until at least 10 minutes have elapsed since the lamp was turned off.
4. Always replace the lamp if any physical damage is evident.
5. Never install the fixture in an enclosed area lacking sufficient air flow; the ambient temperature should not exceed 35°C.
6. A hot lamp may explode. Always wait for at least 10 minutes to elapse after the unit has been turned off prior to attempting to replace the lamp. Always wear suitable hand protection when handling lamps.

Protection rating against penetration by solids and liquids:

1. The projector is rated as an ordinary device. Its protection rating is IP 20

4. Lamp: installation and replacement

Fiera 1200 utilises a Philips 1200 MSD, Philips 1200 MSR or MSR/2 1200W lamp with a G 22 lampbase. The lamp is available from your **coemar** service centre:

Philips 1200 MSD		Philips 1200 MSR		Philips 1200 MSR/2	
coemar cod.	105811	coemar cod.	105090	coemar cod.	105090/2
power	1200 w	power	1200 w	power	1200 w
luminous flux	92.000 lm	luminous flux	110.000 lm	luminous flux	110.000 lm
colour temperature	6.000° K	colour temperature	5.900° K	colour temperature	7.200° K
base	G 22	base	G 22	base	G 22
approximate lamp life	3.000 hours	approximate lamp life	800 hours	approximate lamp life	800 hours

Attention

Disconnect mains prior to opening up the unit.

The fixture's internal temperature can reach 250° C after 5 minutes with a maximum peak of 350° C; ensure that the lamp is cold prior to attempting removal. The fixture should be allowed to stand and cool for 10 minutes prior to its removal. Both MSR and MSD lamps are part of the mercury vapour family of discharge lamps and must be handled with great care. The lamps operate at high pressure, and the slight risk of explosion exists if operated over their recommended lamp life. We recommend, therefore, that the lamp be replaced within the manufacturer's specified lamp life.

installing the lamp

- Using a Philips head screwdriver, loosen the 2 screws which affix the lamp assembly, located at the rear of the projector.



- Remove the lamp assembly



English

3) Locate the lampholder and use a Philips head screwdriver to loosen the screws which affix the lamp support



4) Insert the lamp.

The lamp is manufactured from quartz glass and should be handled with care; always adhere to the instructions supplied in the lamp's packaging. Never touch the glass directly, use the tissue provided in the lamp's packaging. The G 22 lampholder is symmetrical in construction. **DO NOT USE UNDUE FORCE.** In case of difficulty, inspect for physical damage and then repeat the installation procedure.



5) Securely replace the lamp support

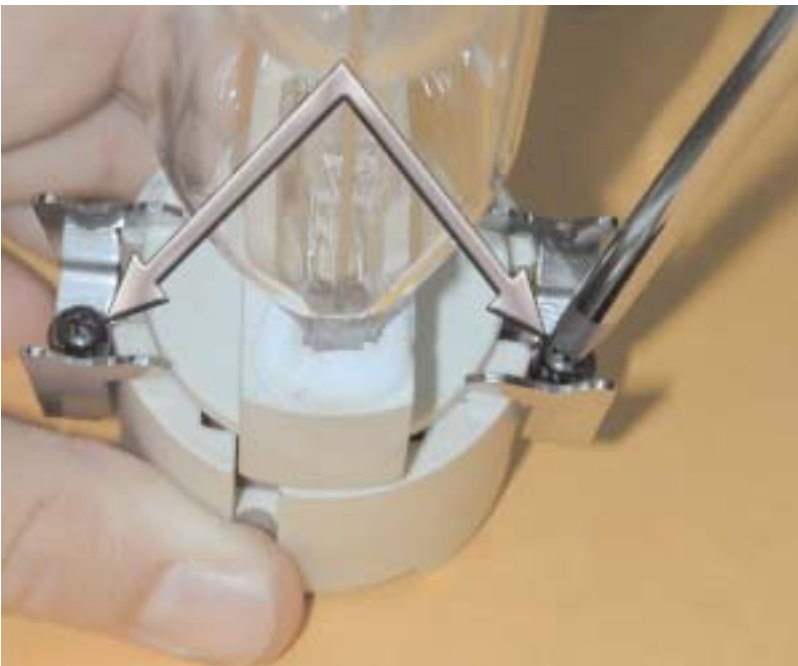

Replace the lamp assembly into its original position and refasten the 2 screws which were previously loosened. Attention: we recommend that you realign the lamp in the optical system of the projector to optimise the output. refer to section 13 for a description of this procedure.

5. Operating voltage and frequency

The projector is able to operate at 200/208,230 or 240V at 50 or 60 Hz; **coemar** preselects (barring specific requests), an operating voltage of 230 V and a frequency of 50 Hz. The operating voltage of the projector is noted on the base of the unit, as shown in the diagram.

factory set main at:

208V~
 230V~
 240V~
 50Hz
 60Hz

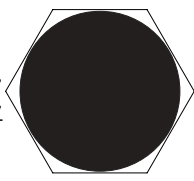

If this preset voltage does not correspond with the conditions in your particular country of operation, follow the instructions in the appropriate section of this manual, section **17. Altering the operating voltage and frequency.**

Incorrect frequency and voltage selection will detrimentally affect the operation of the projector and immediately void the warranty.

6. Mechanical installation

mounting

Fiera 1200 may be suspended or floor mounted.

For the purposes of floor mounting, **Fiera 1200** is fitted with four pads on the base.

For suspending the fixture from lighting truss, **coemar** has included two cam-lock devices (**A**).

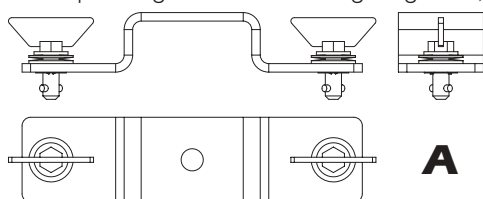

The two cam-lock devices may be installed in 2 diverse positions on the base of the **Fiera 1200**. These devices are 1/4 turn units. To install them, make sure that they are correctly seated into the appropriate slots in the base of the unit.

Posizione 1 / Position 1

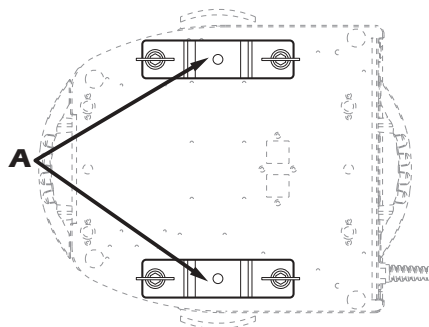

Posizione 2 / Position 2

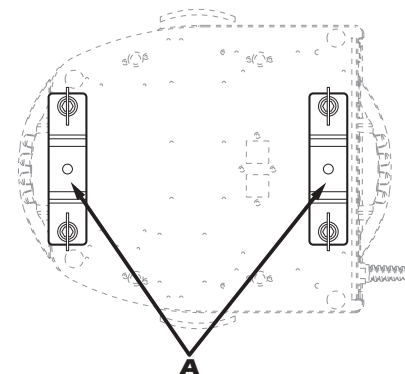

If the fixture is to be suspended, we recommend the use of appropriate C clamps which are capable of comfortably sustaining the weight of the fixture.

The C-clamps are fitted to the central shaft of the cam-lock devices.

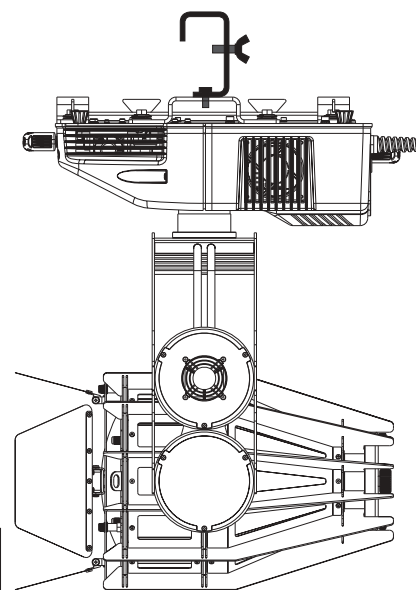

Attention

Always use 2 clamps to suspend the projector

The structure from which the unit is hung should be of sufficient rating to hold the weight of the unit and should also be sufficiently rigid so as to not move or shake whilst the **Fiera 1200** moves during its operation.

English

safety chains

The use of a safety chain fixed to the unit and to the primary suspension structure is highly recommended to protect against the accidental failure, however unlikely, of the primary suspension points.
If using an after-market safety chain not manufactured by **coemar**, ensure that it is of a sufficient rating to hold the weight of the unit.
The safety chain is attached by means of the two holes **B** located in the base of the unit as shown in the diagram.

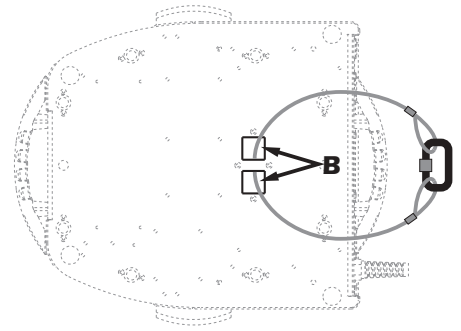

protection against liquids

The projector contains electric and electronic components that must not come into contact with water, oil, or any liquid.

movement

The projector has an articulated movement of 360° in the base and 210° through its yoke; **DO NOT** obstruct the articulated movement in any way.

risk of fire

Each fixture produces heat and must be installed in a well-ventilated position. The minimum recommended distance from flammable material is: 0.5m. Minimum distance from the object being illuminated is: 2m.

forced ventilation

You will note that the projector contains several cooling fans and vents located in the base and the yoke. Under no circumstances should these be obstructed.
Obstruction of any of these points will result in the over-heating of the unit, detrimentally and seriously affecting the proper operation of the fixture.

ambient temperature

Never install the projector in locations where there is insufficient flow of circulating air; the ambient temperature should not exceed 35°C.

7. Mains connection

preparing the cable

The mains cable provided is thermally resistant, having VDE approval and complying to the most recent international standards, namely IEC 331, IEC 332 3C, CEI 20 35.

NB: In case of cable replacement, similar cable with comparable thermal resistant qualities must be used exclusively (cable 3x1,5 ø external 10 mm, rated 300/500V, tested to 2KV, operating temperature -40° +180°, **coemar** cod. CV5309).

mains connection

Fiera 1200 may operate at 208V-230V-240V at 50 or 60Hz (operating voltage and frequency should be selected as discussed in section 5 of this manual).

Prior to connecting the unit to your mains supply, ensure that the model in your possession correctly matches the mains supply available to you.

For connection purposes, ensure that your plug is of a suitable rating: 9 amps.

Locate the mains cable which exits the base of the unit and connect as shown below:

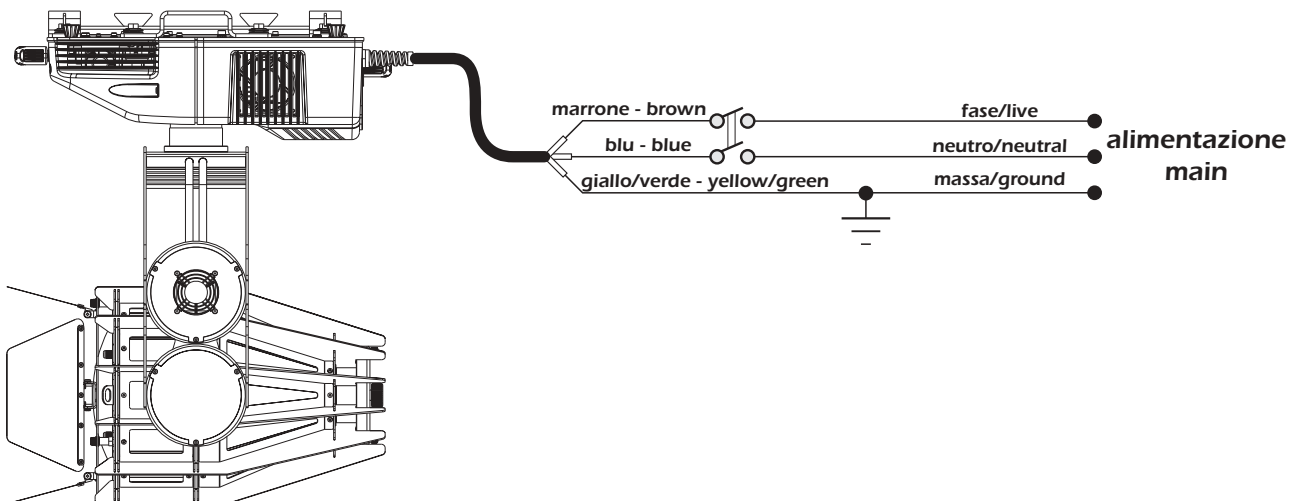

protection

The use of a thermal magnetic circuit breaker is recommended for each **Fiera 1200**.

A good earth connection is essential for the correct operation of the fixture. Strict adherence to regulatory norms is strongly recommended.

8. Signal connection

Control signal is digital and is transmitted via two pair screened $\varnothing 0,5$ cable. Connection is serial, utilising XLR 3 male and female sockets on the base of the **Fiera 1200**, labeled **DMX 512 In** and **OUT** (see diagram).

Pin connection conforms to international standards:

pin 1= screening 0 volt

pin 2= data -

pin 3= data +

Should your **DMX 512** controller utilise only XLR 5 sockets, pins 4 and 5 should not be connected.

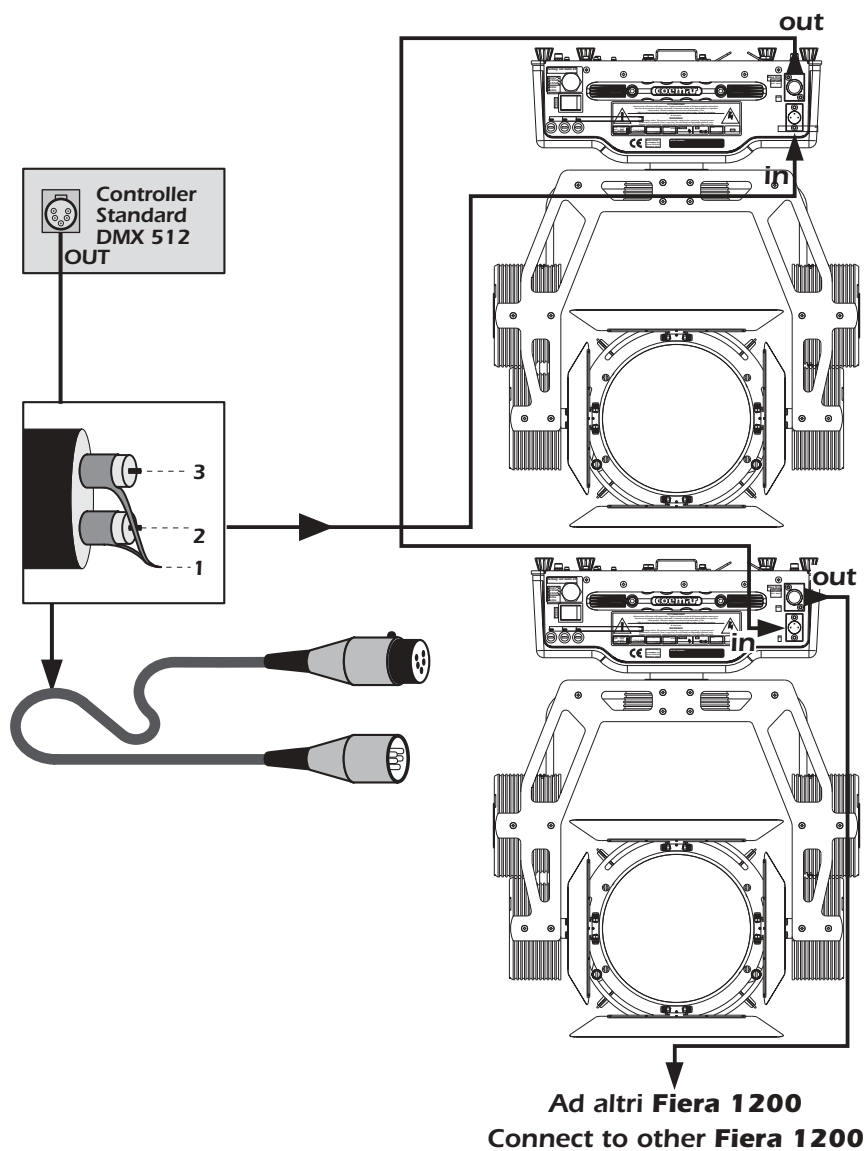

Ensure that all data conductors are isolated from one another and the metal housing of the connector.

Note: the housing of the cannon XLR 3 or 5 must be isolated.

9. Powering up

After having followed the preceding steps, turn on the projector via the **power** button. upon powering up, the projector will perform a reset on all its motor, allowing them to be correctly aligned.

Software version

Three software systems are located within the projector, located in the display pcb “**D**” and the master pcbs “**A**” and “**B**”. Upon powering up, the display of the projector will for a few seconds show the software versions installed in the unit. For example, the **Fiera 1200** may show:

D1.20 (display software “**D**” version 1.20)

A1.12 (master software “**A**” version 1.12)

DMX reception

After having displayed the software versions, the projector will perform a reset and, following this, the display will stay on in a fixed mode, indicating that the fixture is correctly receiving **DMX 512** signal.

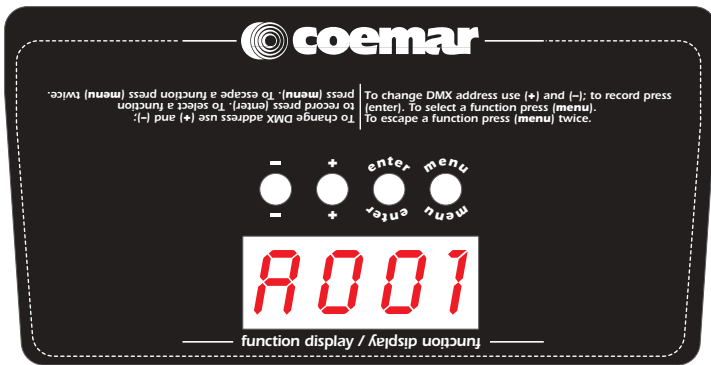

If the display flashed, the projector is not receiving signal. Check the operation of your controller and your cabling.

turning on the projector with no dmx signal present

After having displayed the software versions, the projector will perform a reset and, following this, the display will flash, indicating that the fixture is not receiving **DMX 512** signal.

10. DMX addressing

Each projector utilises **8** of **DMX 512** signal for complete control.(see section **12. DMX 512 signal functions** for more comprehensive information)

DMX addressing

To ensure that each projector accesses the correct signal, it is necessary to correctly address each fixture. Any number between 1 and 505 can be generated via the multifunction panel of the Fiera **1200**.

This procedure must be carried out on every **unit**.

When initially powered up, each projector will show **A001** which indicates **DMX** address **1**; a projector thus addressed will respond to channels **1** through **8** of your **DMX 512** controller. A second projector should be addressed as **9**, a third as **17** and so on until the final **Fiera 1200**, in relation to the number of channels addressable by your controller.

altering the dmx address

1) Press the **+** or **-** until the required **DMX** address is located. The display panel will flash, indicating that the currently displayed address is not recorded.

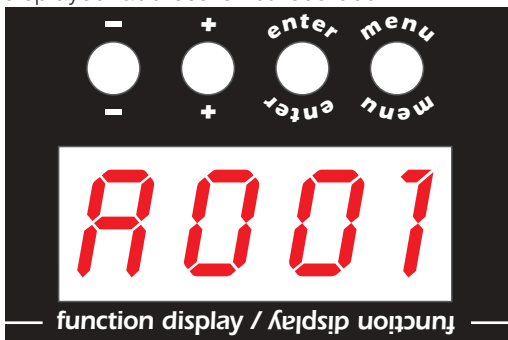

2) Press the **enter** button to confirm your selection; the display panel will stop flashing and the fixture will now respond to the newly assigned **DMX 512** address.

3) To gain an understanding of the functions of each channel of **DMX 512**, we recommend that you read section **12. DMX 512 operation**

Important Note: holding down the **+** or **-** buttons will cause the display to scroll quickly through the channel numbers at an increased speed, allowing a faster selection to be effected.

11. Display panel functions

By using the display panel located on the **Fiera 1200** you are able to display and set function information and to alter various configuration parameters.

Incorrectly altering the **coemar** factory settings may vary the functioning of the projector, causing it to not respond to external **DMX 512** control signal; please read and familiarise yourself with the following information very carefully prior to altering any selections.

NOTE: the  symbol is used in the following table to indicated the action of pressing the appropriately labeled button.

11.1. Function settings (FUNC)

The projector is able to have several function settings altered in order to personalise its use to your requirements.





R001

 menu

 +0-

FUNC

functions menu
The unit gives the possibility to vary some functional settings and to apply personalizations.

 enter	PD IR pan movement inversion To reverse horizontal movement direction of the beam on DMX level variation	 enter	 +0-	CW clockwise	 enter
			 +0-	CCW counter-clockwise	 enter
 +0-	TD IR tilt movement inversion To reverse vertical movement direction of the beam on DMX level variation	 enter	 +0-	CW clockwise	 enter
			 +0-	CCW counter-clockwise	 enter
 +0-	OPTO automatic repositioning To deactivate the optic sensor function with return in position of the unit if accidentally knocked out of place (opto OFF)	 enter	 +0-	ON sensors activation	 enter
			 +0-	OFF sensors deactivation	 enter
 +0-	LAMP lamp control Lamp on/off via DMX signal or lamp always on.	 enter	 +0-	STRD lamp control via DMX 512	 enter
			 +0-	ON lamp always on	 enter
 +0-	FANS fans control Fans speed control through PCB depending on ambience temperature (Std), or fans always on (on).	 enter	 +0-	STRD variable fan speed	 enter
			 +0-	ON fans always on	 enter
 +0-	DISP reverse display To reverse display reading depending on mounting position (base or suspended)	 enter	 +0-	RR base downwards	 enter
			 +0-	BB reversed, base upwards	 enter
 +0-	LED display control To disable display visualisation	 enter	 +0-	OFF to switch the display off ( any key to switch it on)	 enter
 +0-	RESE reset reset of all motors	 enter	 +0-	--- reset activation	 enter
 +0-	DFSE default functions setting to set all the functions at the original values, but for the alignment operations and for the recorded programs	 enter		SURE flashing	 enter
 +0-	DEMO demo program demonstration of all the functions of the unit	 enter		--- program activation	
 +0-	ID ID number setting To set the ID number of the unit, it allows the remote dialog with DR1 on dmx 512 line	 enter		1--250 numeric value	 enter

English

11.2. Measure and test (MEAS)

The electronic pcbs of the **Fiera 1200** allow for various digital and auto-diagnostic measurements to be made.

You may, in this section, record a home position to which the projector will return when it is turned on in the absence of dmx signal.

ROO1

menu

+0-

MEAS

TEMP

temperature

to measure the internal temperature in C°

enter

58C

temperature measurement

+0-

VOLT

voltage to PCB

to measure the DC voltage to the PCB

enter

30.0 V

voltage measurement

+0-

DMIN

DMX value on each channel

reading of DMX value (0/255), received by each of the 8 channels that focus take on DMX 512 line

enter

CH01

from channel 1

enter

10

DMX value reading

+0-

enter

CH08

to channel 8

enter

255

DMX value reading

RATE

DMX rate

reading of DMX 512 signal value named rate

enter

24

value reading

+0-

HOUR

working time

working time (in hours)

enter

LIFE

lamp life after last reset

enter

10

value reading

N.B.: reset the **LIFE** value when changing the lamp

+0-

enter

UNIT

projector life

enter

1230

value reading

TEST

test

function test

enter

PAN

pan movement test

enter

0128

+0-

+0-

TILT

tilt movement test

enter

0128

+0-

+0-

STOR

recording of projector position after reset procedure

enter

SURE

maximum security

enter

press to confirm

11.3. Quick guide to menu navigation

The following guide will allow you to scroll quickly through the various menus located in the display.

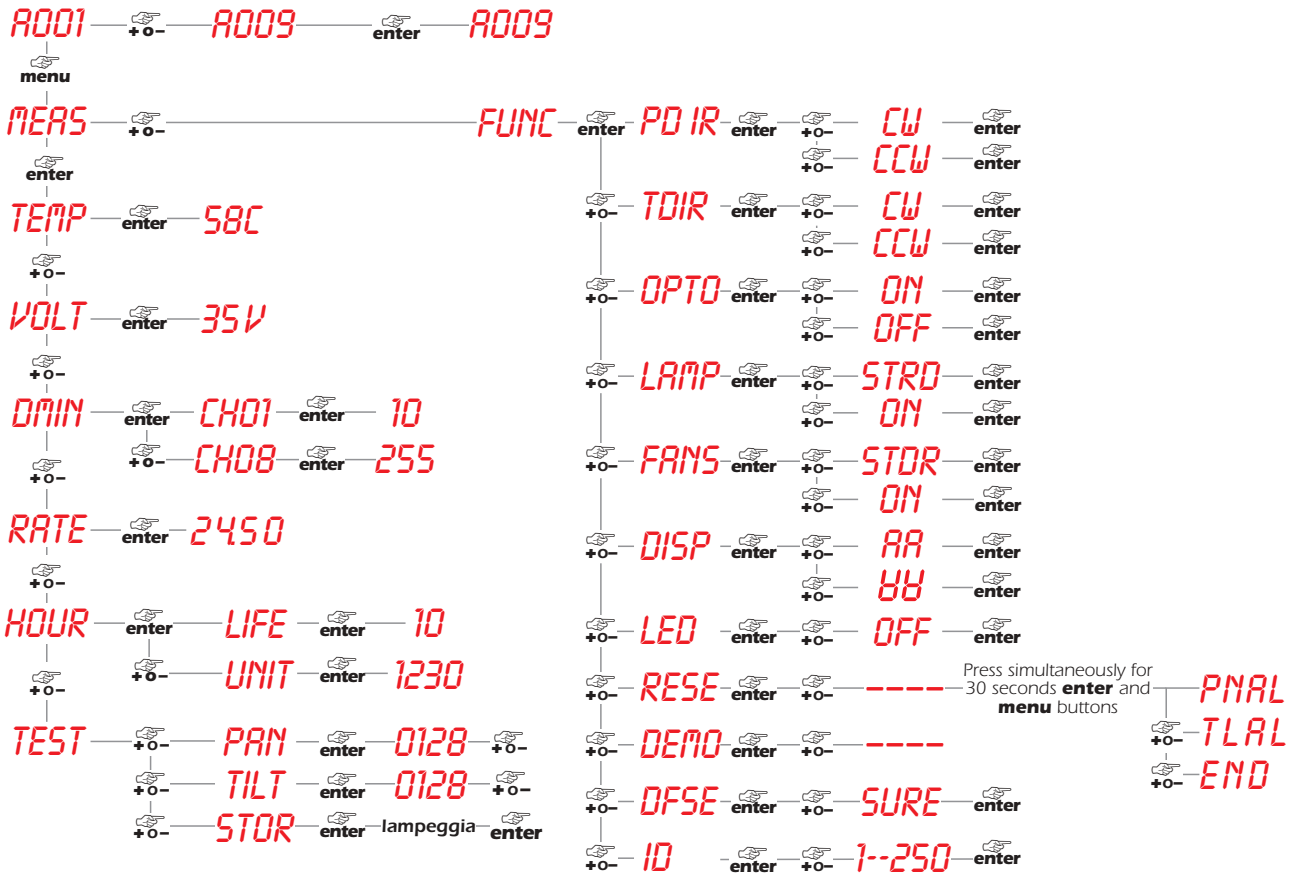

11.4. Rapid scrolling

Via the display of the **Fiera 1200** it is possible to quickly alter the numerical values associated with the various parameter settings. There are three methods for doing this:

- 1) Pressing and holding the + or - buttons will cause the display to scroll rapidly in sequence through the numerical values.
- 2) Pressing and holding the + button and then pressing and holding down the - button will cause the display to jump to the highest possible value associated with the respective parameter.
- 3) Pressing and holding the - button and then pressing and holding down the + button will cause the display to jump to the lowest possible value associated with the respective parameter.

12. DMX 512 operation

If all the procedures have been carried out correctly to this point, the 8 channels of your **DMX 512** controller will have control over all the functions of the **Fiera 1200** as described in the table below:

channel	function	type of control	effect	decimal		percentage	
1	Pan (X axis) movement, coarse	proportional	coarse (8 bit) positioning of pan	0	255	0%	100%
2	Pan (X axis) movement, fine	proportional	fine (16 bit) positioning of pan	0	255	0%	100%
3	Tilt (Y axis) movement, coarse	proportional	coarse (8 bit) positioning of tilt	0	255	0%	100%
4	Tilt (Y axis) movement, fine	proportional	fine (16 bit) positioning of tilt	0	255	0%	100%
5	movement speed	step	standard (fast)	0	10	0%	4%
		step	ultra fast movement (ideal for positioning during programming)	11	25	4%	10%
		proportional	vector mode, fast to slow	26	127	10%	50%
		proportional	Tracking mode (from fast to slow)	128	247	50%	97%
		proportional	Tracking mode (slow)	248	255	97%	100%
6	no effect		spare, makes the light compatible with Electronic ballast version				
7	no effect		spare, makes the light compatible with Electronic ballast version				
8	lamp on/off, motor reset, fan control	step	park, no function	0	10	0%	4%
			lamp off	11	29	4%	11%
			park, no function	30	135	12%	53%
			pan and tilt reset (once only)	136	170	53%	67%
			fan max speed	171	249	67%	98%
			lamp on, fan silent (if internal temperature allowed)	250	255	98%	100%
Note 1: The display panel may be used to disable the switching off of the lamp via DMX							
Note 2: turning off the lamp and all the reset functions are delayed by 6 seconds to prevent accidental activation							
Note 3: the lamp on/off function can only be effected if an opposite level is set							
Fixture: coemar FIERA 1200			Table name: DMX 512				
Chart number: 232		Edition: 1		Date:23/10/2003			

13. Aligning the lamp in the optical path and adjusting the beam

Aligning the lamp in the optical path is achieved by altering the three adjusters located on the rear of the fixture. This procedure should be undertaken to properly align the lamp in the optical system, thus avoiding the possible overheating of internal components and ensuring the maximum luminous output from the fixture.

aligning

Alignment is effected by altering the two adjusters **B** and **C** simultaneously, with the lamp on.

Output from a non-aligned lamp will be noticeable for a hot-spot; adjustment will bring the hot spot towards the centre of the beam, flattening it in the process.

Vertical adjustment

Adjuster (**C**) acts on an internal lever and spring assembly which moves the lamp vertically toward the centre of the parabolic reflector; rotate it until the correct positioning is achieved.

Horizontal adjustment

Adjuster (**B**) acts on an internal lever which moves the lamp horizontally in the centre of the parabolic reflector; rotate it until the correct positioning is achieved.

Axial adjustment (spot/flood)

Adjuster (**A**) moves the entire lampholder assembly axially within the reflector, rotate it until a flat, even beam is produced, with no noticeable hotspot.

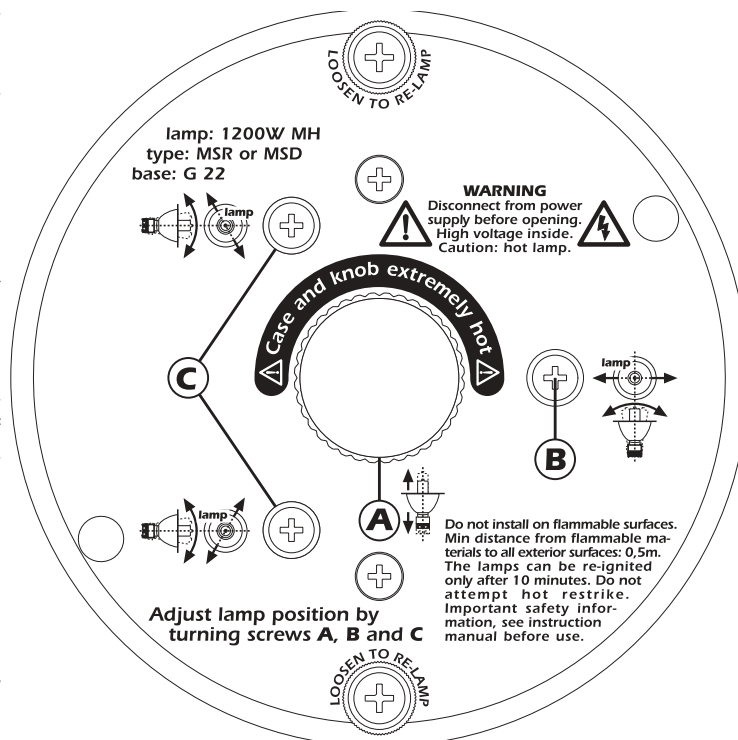

Attention/Danger

Adjuster (**A**) can become extremely hot after only a few minutes of lamp operation. Lamp alignment should be undertaken within 5 minutes of the lamp being turned on. During this procedure, do not touch the body of the projector.

14. Turning on the *Fiera 1200* without articulated movement

This procedure may be useful in situations where the *Fiera 1200* may need to be switched on in an enclosed space, such as in its flight case.

- 1) Turn on the projector whilst holding down the **enter**, **menu** and **-** buttons simultaneously. The projector will perform a reset of its electronic systems without any motor movement.
- 2) You may alter the DMX address or any other parameter at this point without any articulated movement.
- 3) To return to normal operation of the *Fiera 1200* turn the unit off and on via the **power** button, or effect a reset via the menu system.

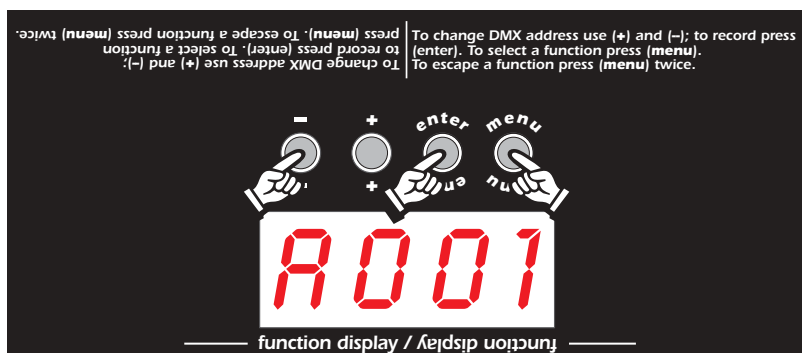

15. Resetting the counter

The electronic counter should be reset every time a lamp is changed in the projector. so that realistic information about lamp life may be obtained. Upon turning on the **Fiera 1200**, simultaneously press the **+** and **-** buttons. In this manner, the counter will be reset.

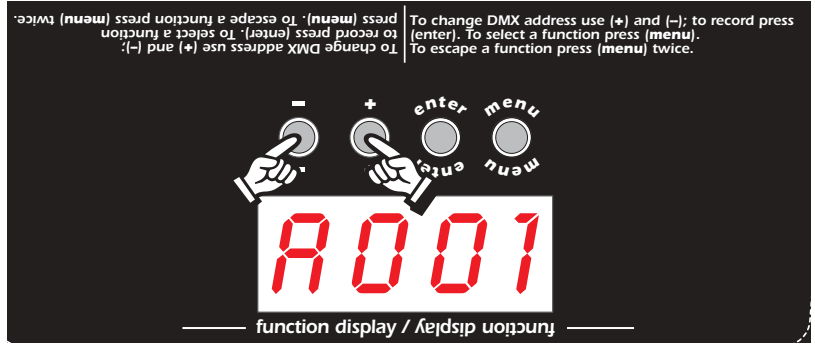

After the projector has reset the lamp life counter **LIFE**.

To verify that the procedure has taken place, undertake the following steps:

- 1) Press the **menu** button; the projector will show **MODE**
- 2) Press the **+** button for **MERS** to be displayed.
- 3) Press the **enter** button
- 4) Press the **+** or **-** buttons until **HOUR** (display in hours) is displayed.
- 5) Press the **enter** button
- 6) Press the **+** or **-** buttons until **LIFE** (for lamp life) is displayed.
- 7) Press the **enter** button; the display will show **0000** confirming that the counter has been reset.

N.B. You may verify that the other counters **LIFS** (for total lamp life of all lamps utilised) and **UNIT** (operating life of the projector) have not been reset.

16. Automatic repositioning feature

An encoder system based on 4 position indicators allows the **Fiera 1200** to return to its correct position if it is accidentally moved during operation.

This is particularly useful if the projector is to be mounted on the floor in a position where the performer or artist may accidentally bump the unit.

NOTE: this function may be disabled (display panel function **OPTO OFF**).



17. Altering the operating voltage and frequency (Reserved for technical staff)

If the operating voltage and frequency set by **coemar** does not correspond to that is use in your country of operation, or if the projectors are destined for use in another country, a new operating voltage and frequency selection may be made as described below.

Incorrect frequency and voltage selection will detrimentally affect the operation of the projector and immediately void the warranty.

The operating voltage and frequency must be selected on both the power supply (lamp power) and the transformer (electronics power).

17.1 Selecting an operating voltage and frequency for the lamp different to the factory preset.

With this procedure you may determine the current which the lamp will operate once it has ignited: the current value is 13,8 Amp. For a correct selection to be made, you must know the operating voltage and frequency with which the projector will be supplied when in use.

1) Remove the screws on the base housing using a Philips head screwdriver as shown in the diagram below; completely remove the cover, thus providing full access to the internal components in the base of the **Fiera 1200**



3) Locate the connections on the power supply marked 208/230/240 V and 50 or 60Hz; to which are connected the cables which determine the operating voltage and frequency of the lamp.

4) The cables 12 and 13 determine the operating voltage. Move them amongst the options 208, 230 and 240V available for the ballast.

5) Cables 15 and 16 determine the operating frequency. Move them amongst the options 50 and 60Hz available for the ballast.

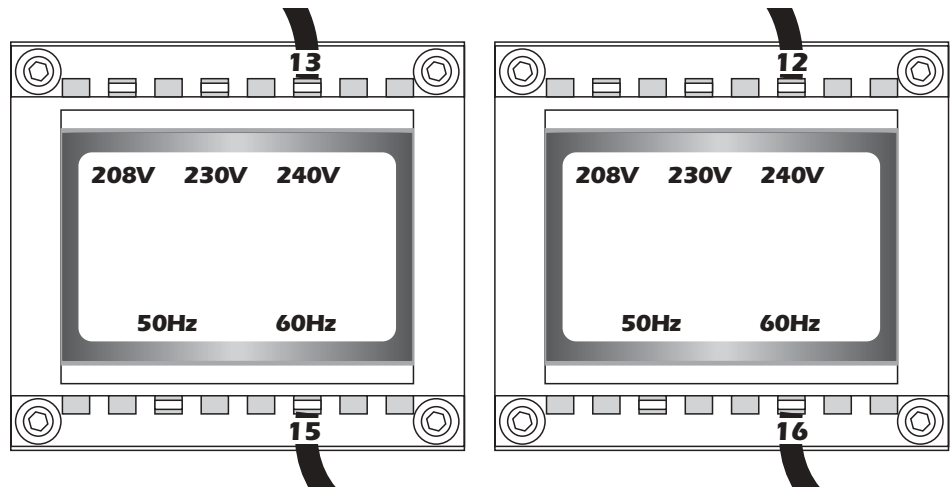

6) After having selected the operating voltage and frequency for the lamp, proceed to make the appropriate selection for the transformer's operating voltage, as described in the sections which follow.

English

17.2 Selecting the transformer operating voltage.

This procedure allows you to alter the operating voltage for the electronic circuitry and motors in the fixture. You will need to be aware of the mains voltage available to you in your particular installation.

- 1) Locate the transformer in the base of the unit.
- 2) Select from either 208, 230 or 240V by disconnecting cable n° 5 and moving it to the required voltage. To ensure a correct selection, refer to the sticker located on the transformer. Under no circumstances should cables number 7 and 8 be moved.



- 3) Replace the base cover and re-affix all screws as per their original positions.
- 4) Make a clear note of the new operating voltage and frequency on the outside of the base of the **Fiera 1200**.

factory set main at:

<input type="checkbox"/> 208V~	
<input type="checkbox"/> 230V~	
<input checked="" type="checkbox"/> 240V~	
<input checked="" type="checkbox"/> 50Hz	
<input type="checkbox"/> 60Hz	

18. Mechanical adjustments

After having powered up the unit and checked all the functions via **DMX 512** control signal, you may need to effect some mechanical adjustments to the projector to suit your particular installation.

18.1 Adjusting the beamspread using optional filters

There are several optional filters which can be utilised to alter the dimensions of the output of the projectors to suit specific lighting applications.

All the lenses and diffusion filters are rotatable, thus allowing adjustment of the output through 360°



- Beamspread: circular
Transparent filter
cod. VT 194



- Beamspread: circular
Prismatic medium diffusion filter
cod. LE 06



- Beamspread: rectangular
Prismatic, maximum-diffusion filter
cod. LE 05

English

To facilitate the operation of replacing the optional filters, we suggest rotating the fixture head in a position perpendicular to the base.

Attention!

Prior to lense replacement, remember to turn off the fixture and allow it to cool.
Never expose yourself directly to the light output from the front of the unit. Make sure that the lenses are not cracked or chipped. Use only **coemar** approved lenses.

- 1) Using a flat screwdriver, loosen the 4 screws which affix the lense and barndoor retaining ring.
- 2) Rotate the retaining ring to which the barndoors are attached, thereby removing it.



- 3) Remove the lense you intend to replace.



- 4) Insert the new lense, determining the rotated position you wish it to occupy. Lenses are rotatable through 360°
- 5) After installing the new lense, reposition the retaining ring and refasten the 4 screws previously loosened.

18.2 Adjusting the barndoors

The 4 leaf barndoors allow the beam output of the projector to be masked and adjusted to suit your requirements. The barndoors may be adjusted individually and may be rotated as a group.

18.2.1 Individual leaf adjustment

1) Each of the 4 leaves may be individually adjusted by pushing it towards or away from the lense, allowing for more or less masking of the beam output. If needed, you may loosen or tighten the mechanism as shown in the diagram.

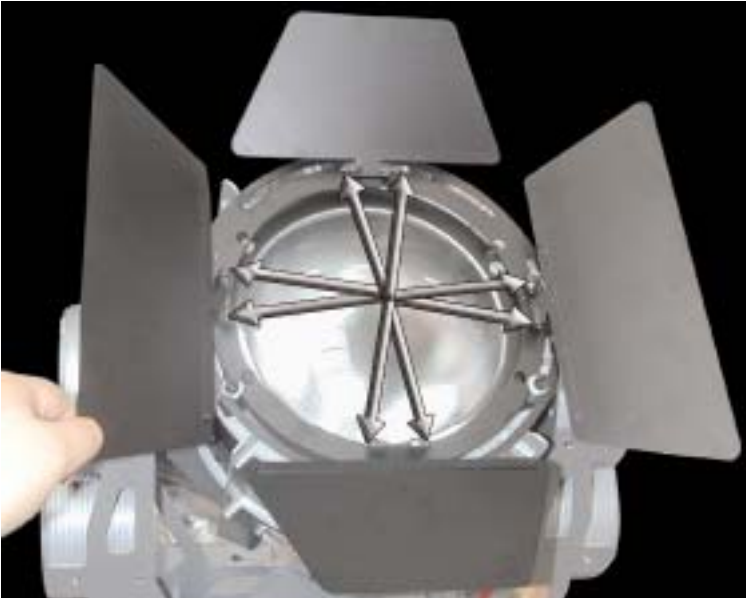

Attention!

To avoid overheating the fixture, never full close the barndoors whilst the lamp is on.

2) If you should find it necessary to loosen the individual barndoors to adjust their position, ensure that you retighten them sufficiently to avoid them sagging.

18.2.2 Rotating the barndoors

1) The barndoor group may be rotated through 90° by loosening the three adjusters as shown in the diagram.

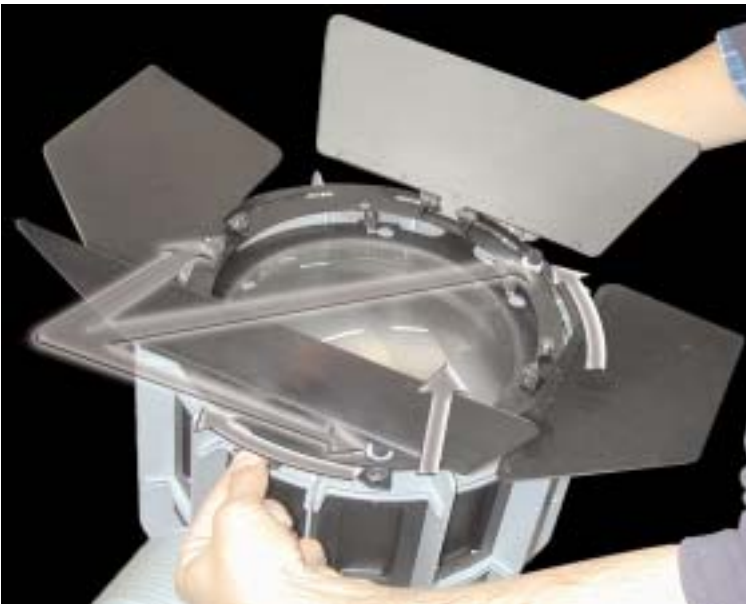

Attention!

Never remove the 4 leaf barndoors completely - this may result in the fixture being unbalanced and not articulating correctly.

2) Retighten the three adjusters after having repositioned the barndoors, so that they remain in the required position during articulated movement.

19. Automatic internal functions

Fiera 1200 has several internal automatic functions which may not be noticed in the first instance but which, nonetheless, may assist the operator in making best use of the projector.

lamp on timer

This internal system in the electronic ballast governs the start up process so that if a prolonged unsuccessful attempt (over 20 seconds) is made to strike the lamp, the device will then automatically attempt to strike the lamp for 20 seconds once every minute for the following 8 minutes. After this the lamp circuit is disabled (assumes a failed lamp).

This device protects the transformer and ignitor.

NOTE: it is then necessary to remove the fixture from mains power and replace the lamp.

temperature controlled cooling fans

A thermal sensor in the body of the **Fiera 1200** constantly monitors the internal temperature of the fixture to ensure that it remains at an optimal level.

The electronic circuitry of the **Fiera 1200** is designed to compensate for a rise in the internal temperature of the unit by increasing the cooling fan speed.

In this manner, the internal components of the fixture are maintained in an optimal temperature range and the fans are operating at the minimal speed required, thus minimising any noise.

NOTE: If you wish to maintain the fans at the maximum operating speed, you may do this via the display function (function **FAN ON**) or directly by keeping DMX channel 8 at a level between 171 and 249.

automatic return to position

An encoder system based on 4 position indicators allows the **Fiera 1200** to return to its correct position if it is accidentally moved during operation.

This is particularly useful if the projector is to be mounted on the floor in a position where the performer or artist may accidentally bump the unit

NOTE: this device may be deactivated (see section 11 Display panel functions - **OPTO OFF**), to return to its correct position if it is accidentally moved during operation.

20. Maintenance

Whilst every possible precaution has been taken to ensure the trouble-free operation of your **Fiera 1200**, the following periodic maintenance is highly recommended. Prior to undertaking any maintenance procedure, make sure the fixture is disconnected from mains power.

Attention

Disconnect mains power prior to opening up any housing.

Periodic cleaning Lenses and reflectors

Even a fine layer of dust can reduce the luminous output substantially. Regularly clean all lenses and the reflector using a soft cotton cloth, dampened with a specialist cleaning solution.

Fans and air passages

The fans and air passages must be cleaned approximately every 6 weeks; the period for this cleaning will depend, of course, upon the conditions in which the projector is operating. Suitable instruments for performing this type of maintenance are a brush and a common vacuum cleaner or an air compressor.

Periodic maintenance Lamp

The lamp should be replaced if there is any observable damage or deformation due to heat. This will avoid the danger of the lamp exploding.

Mechanicals

Periodically check all mechanical devices for wear and tear, gears, guides, belts, etc, replacing them if necessary. Periodically check for mechanical damage and replace components as required. Check the tensioning of all belts and adjust if necessary.

Electrical components

Check all electrical components for correct earthing and proper attachment of all connectors, refastening if necessary.

Replacing fuses

Locate the fuses which protect the lamp and internal circuitry. These are indicated by labels on the base of the **Fiera 1200**. Use a multimeter to check the condition of the fuse, replacing it with one of similar value if required.

21. Electronic motor alignment

Reserved for technical staff

The display panel of the **Fiera 1200** allows for the electronic alignment of the projector's motors. This procedure is performed by **coemar** at the factory. It may be useful to perform this procedure in the case of internal components being replaced. Altering the factory settings may radically alter the functioning of the projector. Carefully read all of the following prior to attempting any following prior to attempting any changes.

electronic calibration

Important Note: A **DMX 512** controller must be connect to the fixture in order to carry out this procedure.

- 1) Press the **menu** button.
- 2) Press the **+** or **-** buttons until **RESE** (for reset) is displayed.
- 3) Simultaneously press the **enter** and **menu** buttons holding them down for at least **30"**. The motors will perform a reset, and the display will show **----** for some few seconds, indicating you have commenced the calibration procedure:

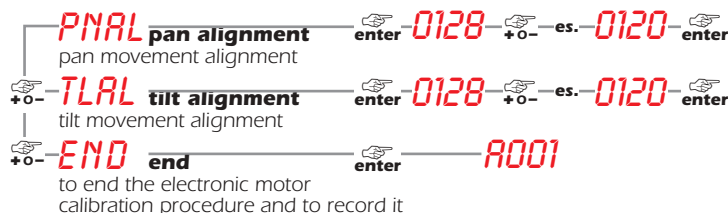

simultaneously



NOTE:

To speed up the alignment/setting procedure it is possible, during the function, to press simultaneously **+** and **-** buttons; the display will go automatically at 128

22 Error messages

MBER:	COMMUNICATION Error The display panel is not communicating correctly with the main pcb: check the flat ribbon cable which connects the two.
OPER:	PAN ENCODER Error This message indicates that there is a problem with the PAN Encoders: Check the sensors and all associated cabling on the wheel which is used to determine the PAN movement in the base
OTER:	TILT ENCODER Error This message indicates that there is a problem with the TILT Encoders: Check the sensors and all associated cabling on the wheel which is used to determine the TILT movement in the yoke
SNER:	LINE SYNCHRONISATION Error Check and replace opto-isolator U9.
EPER:	EEPROM Error The EEPROM is either defective or is absent; refer to your coemar service centre for a replacement component.
OTER:	DATA Error The initial parameter settings are either incorrect or corrupt, the projector has reloaded its factory defaults: Turn the projector off and on again. Should the error reoccur, refer the unit to your authorised service centre for a replacement EEPROM
ER20 ÷ ER99:	SYSTEM Error Turn the unit off and then on again. Should the error reoccur, refer the unit to your authorised coemar service centre.

23. Spare parts

All the components of the **Fiera 1200** are available as spare parts from your authorised **coemar** service centre. Accurate description of the fixture, model number and type will assist us in providing for your requirements in an efficient and effective manner.



coemar spa

via Inghilterra
46042 Castelfredò (Mantova) Italy
Tel. 0376/77521
Fax 0376/780657

coemar si riserva il diritto di apportare modifiche senza preavviso.
coemar reserves the right to effect modifications without notification

manuale istruzioni
instruction manual

Fiera 1200

1[^] edizione: ottobre 2003
1st edition: october 2003